	SERVICE BULLETIN	
	Flight Design GmbH Sielminger Str. 51 D-70771 L.-Echterdingen Tel +49 (0)711 90287-0 Fax +49 (0)711 90287-99 E-Mail: airworthiness@flightdesign.com	SB-SECS-CT__-02, SB-SECS-CT2k-03, SB-SECS-CTSW-04 Revision 01
		Date of Initial Publication: 08-Jun-2009 Publication Date of this Revision: 06-May-2010

SERVICE BULLETIN

Fuel Filter Exchange

SB-SECS-CT__-02
SB-SECS-CT2k-03
SB-SECS-CTSW-04

1 Planning Information

1.1 Affected Aircraft

Type: CT

Model: models CT2K, CTSW, CTLS

Serial Number: All serial numbers prior to D-09-02-10 or F-09-02-01 (usage of letters at beginning of S/N started in 2008, therefore all S/N beginning without a letter are affected)

Applicable Countries: All Countries

1.2 Concurrent Documents

SN-SECS-CT__-07, SN-SECS-CT2k-09, SN-SECS-CTSW-05

1.3 Reason

Usage of fuel with high ethanol content, combined with long down time of the aircraft can lead to a degradation of the fuel filter installed up to now behind the instrument panel, close to the fuel shut off valve. This can lead to a discolored filter and in extreme cases to deformation of the filter.

1.4 Subject

Inspection of the installed fuel filter for signs of degradation.

Exchange of the fuel filter with a new fuel filter made of from aluminum with improved overall capabilities.

While work is performed on the fuel filter location, some older CTSW aircraft must be updated further. A piece of fuel hose shall be replaced with a curved piece of stainless steel tube to relieve the load on the hose radius.

1.5 Compliance

The inspection as by 2.4 must be performed before the next flight.

If the curved stainless steel tube is installed (ex factory or already retrofitted) and no Ethanol mixed fuel has been used, exchange of the fuel filter must be done within 3 months from issuing of this SB, latest at the next 100 hrs inspection (refer to chapter 2.4)

Until exchange of the fuel filter is completed the aircraft may only be operated when actively avoiding Ethanol blended fuel (refer to chapter 2.5).

	SERVICE BULLETIN	
	Flight Design GmbH Sielminger Str. 51 D-70771 L.-Echterdingen Tel +49 (0)711 90287-0 Fax +49 (0)711 90287-99 E-Mail: airworthiness@flightdesign.com	SB-SECS-CT__-02, SB-SECS-CT2k-03, SB-SECS-CTSW-04 Revision 01
		Date of Initial Publication: 08-Jun-2009 Publication Date of this Revision: 06-May-2010

1.6 Personnel Qualifications

National maintenance and inspection regulations as applicable for line maintenance apply.

1.7 Approval

Inspection and result must be noted in the aircraft logbook together with the result of the inspection, with name and qualification of the person conducting the task.

Exchange of the filter must be documented in the aircraft logbook with name and qualification of the person conducting the task.

1.8 Weight and Center of Gravity

Not affected

1.9 References

CT Parts and Maintenance Manual

CT Aircraft Maintenance Manual

1.10 Superseded Documents

SB-SECS-CTSW-03

1.11 Contact Details

For further information on conduct of this SB, or to report any Safety of Flight or Service Difficulty issues contact your Distributor responsible for your country. Your Distributor can be located via the Flight Design website: www.flightdesign.com under "Dealer Location".

In cases where the local distributor is unknown or not available contact Flight Design GmbH directly: airworthiness@flightdesign.com

2 Resources

2.1 Materials

- New aluminum fuel filter
- Metal hose segment (as required)

2.2 Manpower

Typically the procedure takes one hour to complete, including drainage of the fuel.

2.3 Cost

The national Flight Design Distributor can supply you with the spare parts upon notification of the affected aircraft S/N. The local price will vary depending on the cost of shipping and duties.

	SERVICE BULLETIN	
	Flight Design GmbH Sielminger Str. 51 D-70771 L.-Echterdingen Tel +49 (0)711 90287-0 Fax +49 (0)711 90287-99 E-Mail: airworthiness@flightdesign.com	SB-SECS-CT__-02, SB-SECS-CT2k-03, SB-SECS-CTSW-04 Revision 01
	Date of Initial Publication: 08-Jun-2009 Publication Date of this Revision: 06-May-2010	

2.4 Inspection

Following the procedures provided by the Maintenance Manual, remove the lower middle instrument panel. Move it as much that the fuel filter and the fuel hose are accessible, just like is done in every 100 hrs inspection.

Check for the following two aspects:

1. What installation variant is applicable to your CT? Due to the long model history of CT aircraft and due to modifications implemented in field there can be different variants:
 - a. Clear straight disc-shaped plastic filter straight in line with the fuel lines. The filter is located directly upstream of the fuel valve.

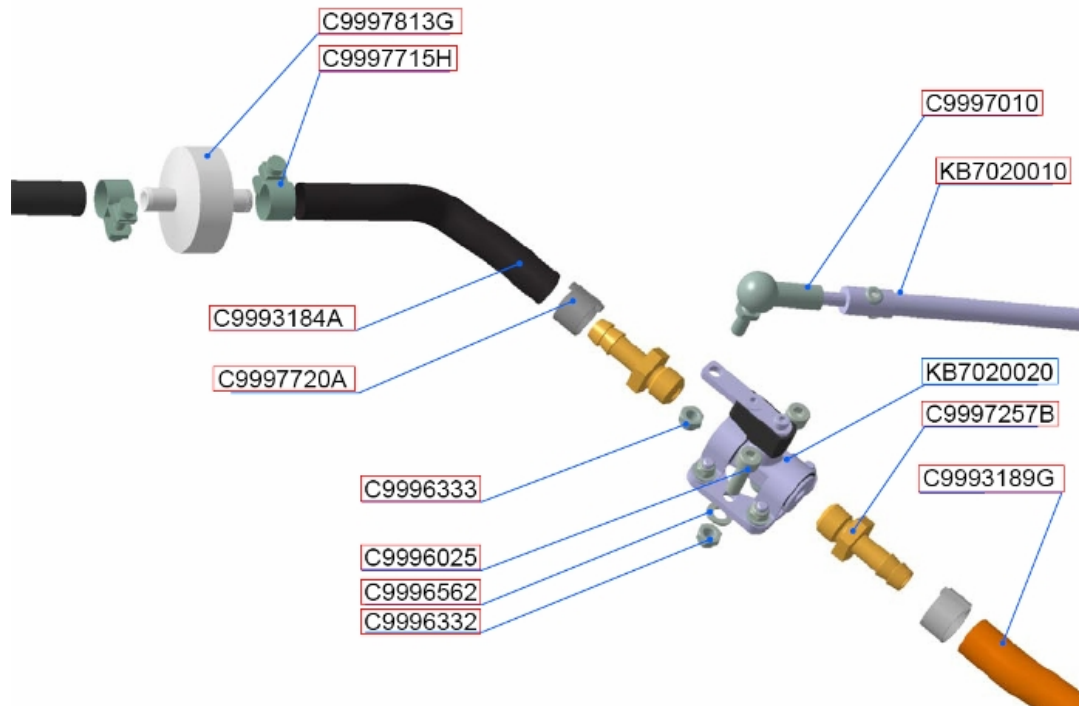

- b. Clear straight disc-shaped plastic filter straight in line with the fuel lines. The filter is located directly downstream of the fuel valve.

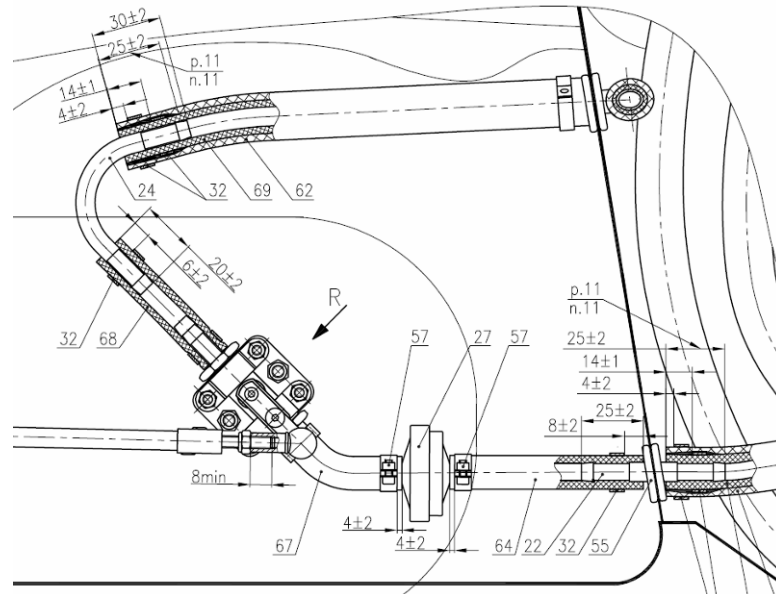

c. Clear thick cylindrical plastic filter with straight inlet and outlet to the side.

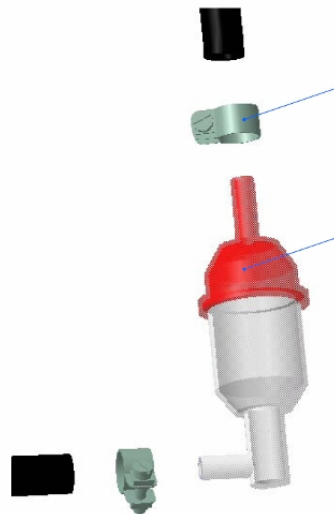

d. Variant not listed above. In this case please take pictures that provide a good overview, describe the setup and provide all this information to Flight Design in order to obtain further instructions.

2. Inspect the filter for unusual conditions. If the filter looks deformed than the filter exchange must be complied with prior to next flight.
3. On CTSW aircraft only, that have the installation according to Variant 1.b. above, is the stainless steel tube installed directly above the fuel filter? (Number 24 in drawing above)

With this information please use the feedback template to order the required spare parts at your FD Service Center or at your local FD distributor.

	SERVICE BULLETIN	
	Flight Design GmbH Sielminger Str. 51 D-70771 L.-Echterdingen Tel +49 (0)711 90287-0 Fax +49 (0)711 90287-99 E-Mail: airworthiness@flightdesign.com	SB-SECS-CT__-02, SB-SECS-CT2k-03, SB-SECS-CTSW-04 Revision 01

2.5 Avoidance of Ethanol Blended Fuel

Until this SB is completed the following must be complied with. To ensure this it is the obligation of the aircraft owner to properly inform all pilots about this requirement.

1. It is highly recommended to only use fuel mixed with a maximum of 1% Ethanol content, such as 100LL AVGAS. In some countries so-called ethanol free MOGAS is available as an alternative. Refer to the Rotax Operation manual and request confirmation on the ethanol content from the gas station operator.
2. When it is the intention to directly burn the fuel during a longer flight operation Ethanol blended fuel can be used. The limitations imposed by the engine manufacturer (refer to your applicable engine operation manual) must be obeyed.
3. When the aircraft is planned to be on the ground for longer than 2 weeks, all fuel with an Ethanol mix must be drained from the aircraft.

Warning: The total amount of fuel onboard does not change the storage requirements for Ethanol mixed fuel. Even when the amount of remaining fuel is small, if it has Ethanol content higher than 1% it must be drained prior to a longer down time of the aircraft.

4. When the aircraft was sitting on the ground for a longer period than specified in 3 above with Ethanol blended fuel on board, Inspection as described under Chapter 2.4 Point 2 must be repeated.

2.6 Exchange of Fuel Filter

Refer to the maintenance manual for the procedure for exchanging of the fuel filter. The installed fuel filter with plastic housing must be exchanged with the new Flight Design fuel filter KF28000033.

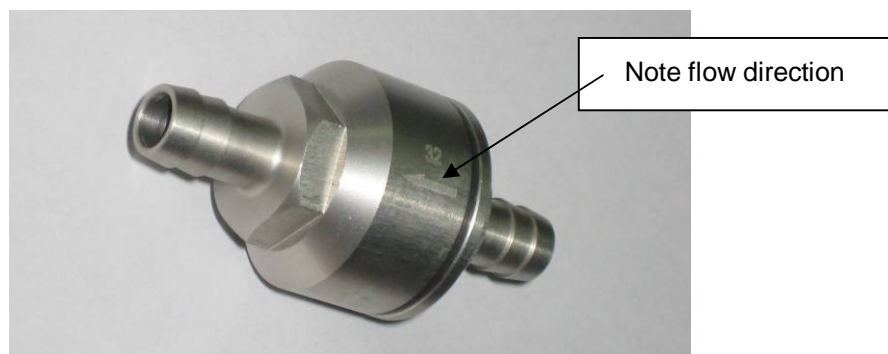

Warning: When installing the fuel filter make sure that the direction of flow is considered correct, as engraved to the fuel filter housing.

In cases where you also have to install the stainless steel fuel line, the installation is illustrated in the following drawing excerpt. Take care that the hose is properly clamped with a regular hose clamp (pos. 32). Depending on the type filter being replaced, larger hose clamps may be required.

	SERVICE BULLETIN	
	Flight Design GmbH Sielminger Str. 51 D-70771 L.-Echterdingen Tel +49 (0)711 90287-0 Fax +49 (0)711 90287-99 E-Mail: airworthiness@flightdesign.com	SB-SECS-CT__-02, SB-SECS-CT2k-03, SB-SECS-CTSW-04 Revision 01
		Date of Initial Publication: 08-Jun-2009 Publication Date of this Revision: 06-May-2010

To inspect the fuel filter it is required to remove at least one hose from the fuel filter. Make sure you drain all fuel in the line behind the fuel shutoff valve, before you remove the fuel filter. Insert a rag or paper towels below the filter to collect potential fuel spillage.

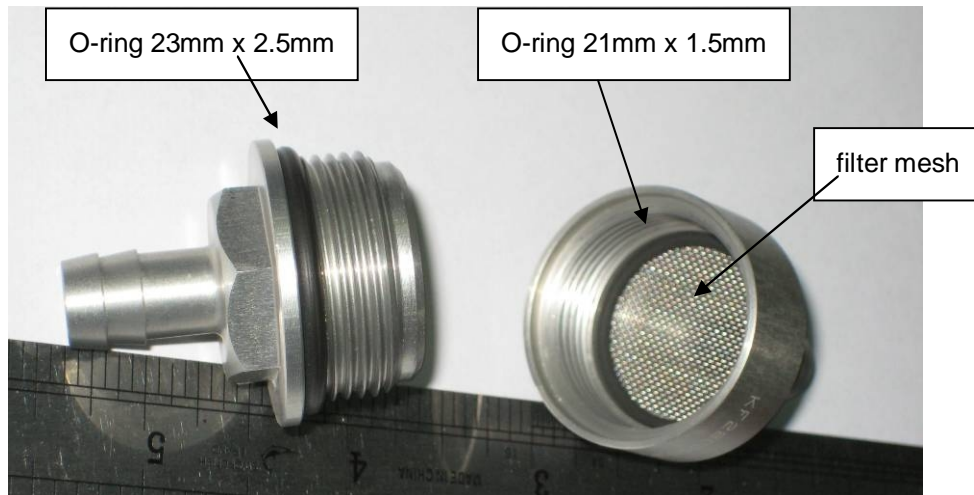

The fuel filter can be easily unscrewed and opened using two 19mm flat wrenches. This reveals the metal mesh inside the downstream half of the fuel filter housing. Inspect the filter mesh and remove any possible dirt. Refer to the aircraft maintenance manual if dirt is found at this location. Inspect the two O-rings and exchange against new O-rings of ethanol resistant Viton, when damaged. Assemble the filter and tighten carefully until the two housing parts just get contact at the separation line.

Re-attach the fuel line where it has been disconnected and carefully tighten the hose clamp. Check for leaks before returning the aircraft into service.

3 Appendix

3.1 Changes to Previous Revision

Superseded document is added

	SERVICE BULLETIN	
	Flight Design GmbH Sielminger Str. 51 D-70771 L.-Echterdingen Tel +49 (0)711 90287-0 Fax +49 (0)711 90287-99 E-Mail: airworthiness@flightdesign.com	SB-SECS-CT__-02, SB-SECS-CT2k-03, SB-SECS-CTSW-04 Revision 01
		Date of Initial Publication: 08-Jun-2009 Publication Date of this Revision: 06-May-2010

3.2 Feedback Template Flight Design

This form has to be used to coordinate with Flight Design the required spare parts and to communicate the completion of the SB listed in the header of this page.

Submission can be done by mail, Fax or as scanned copy per e-mail to Flight Design GmbH (see header of this page) or to your national Flight Design Distributor who will forward the information for you.

Information to obtain spare parts

Aircraft Type: CT
 Model: _____
 Serial Number: _____
 Aircraft Owner, Name and Address: _____

The fuel system installation is of type a. b. c. d.

In case of d. please add pictures and detailed description.

The metal fuel hose is required (only for Variant b.) Yes No

Confirmation of Completion

Conduct of this SB has been done at the following workshop:

Responsible Mechanic:

Date: _____ Location: _____ Signature: _____

Warning: As long as the form has not been submitted to Flight Design, this SB is considered not complied-with for the respective aircraft!